



a·light

**ALOFT**



## **MULTI-AWARD WINNING LUMINAIRE SYSTEM**

“A high degree of functionality and mounting comfort distinguishes this lighting system as a versatile solution for representative lighting concepts.”

– statement by the Red Dot jury



reddot winner 2021  
lighting design



a·light



**ARTICULATE  
YOUR IDEAS  
WITH LIGHT**

With fully articulating elbows and connectors, designers can create unique configurations.

a·light

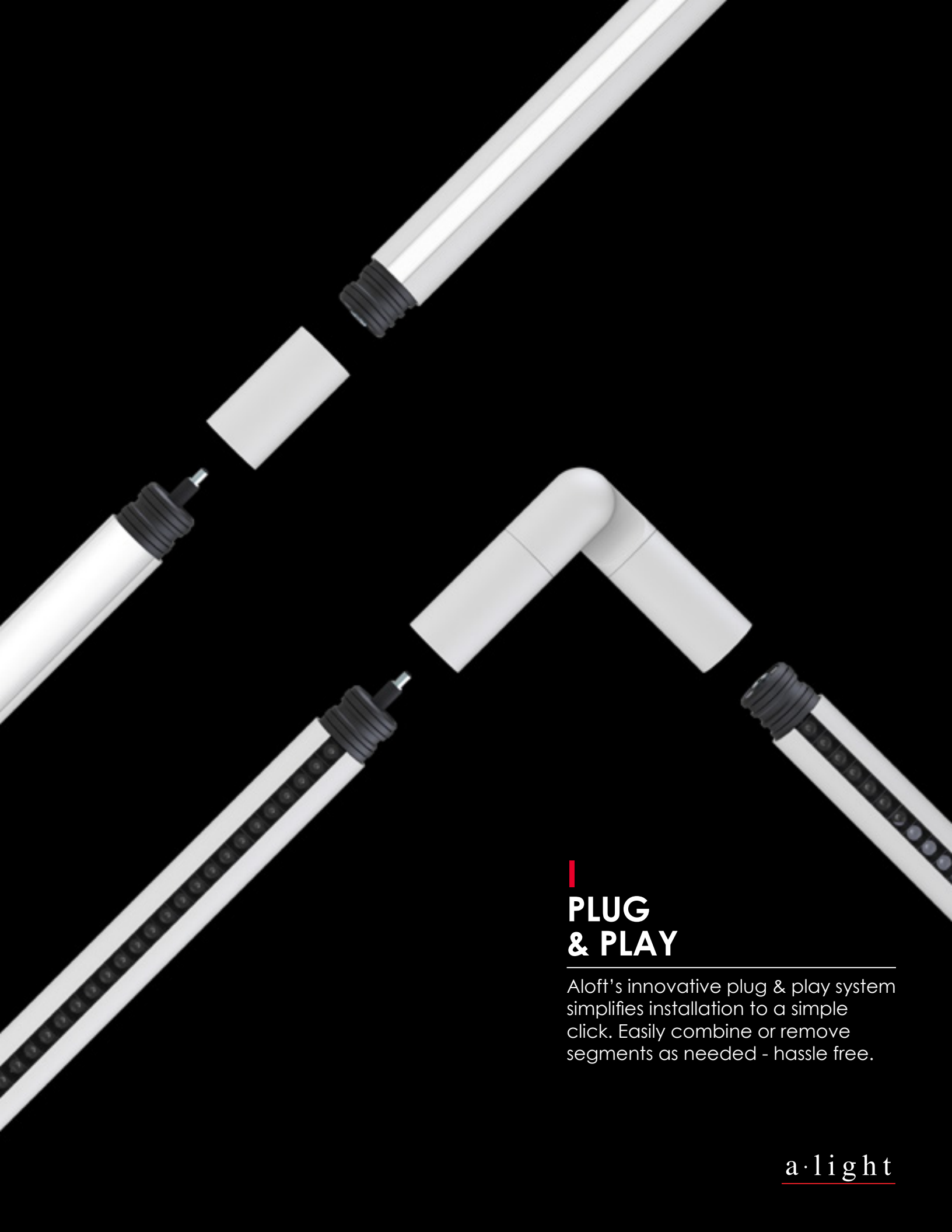

|  
**PLUG  
& PLAY**

---

Aloft's innovative plug & play system simplifies installation to a simple click. Easily combine or remove segments as needed - hassle free.

a·light

A photograph of a modern concrete staircase with recessed lighting. A person is walking on the stairs, blurred to suggest motion. The lighting is integrated into the concrete structure, creating a clean, minimalist aesthetic.

## **FOLLOWING LIGHT**

Why compromise when you can adapt the lighting to its environment? Aloft can be fine-tuned on-site to make last minute changes.

a·light



**BE  
CREATIVE**

The swivel joiner has a wide horizontal rotation which allows for creative use of angles and maximum on-site adjustability.

a·light



| **ABSTRACTION  
MEETS GEOMETRY**

Get more out of your light: use Aloft to create unique patterns and make a lighting statement. No job is too complex for Aloft.

a·light



|  
**TOTAL  
LIBERTY**

---

With a horizontal rotation of 200° and a 360° rotation joiner, Aloft can be shaped into countless configurations.



# LINEAR SEGMENTS

---

Each linear segment of Aloft can be specified with a different light option creating unique looks that can be adjusted to any environment.

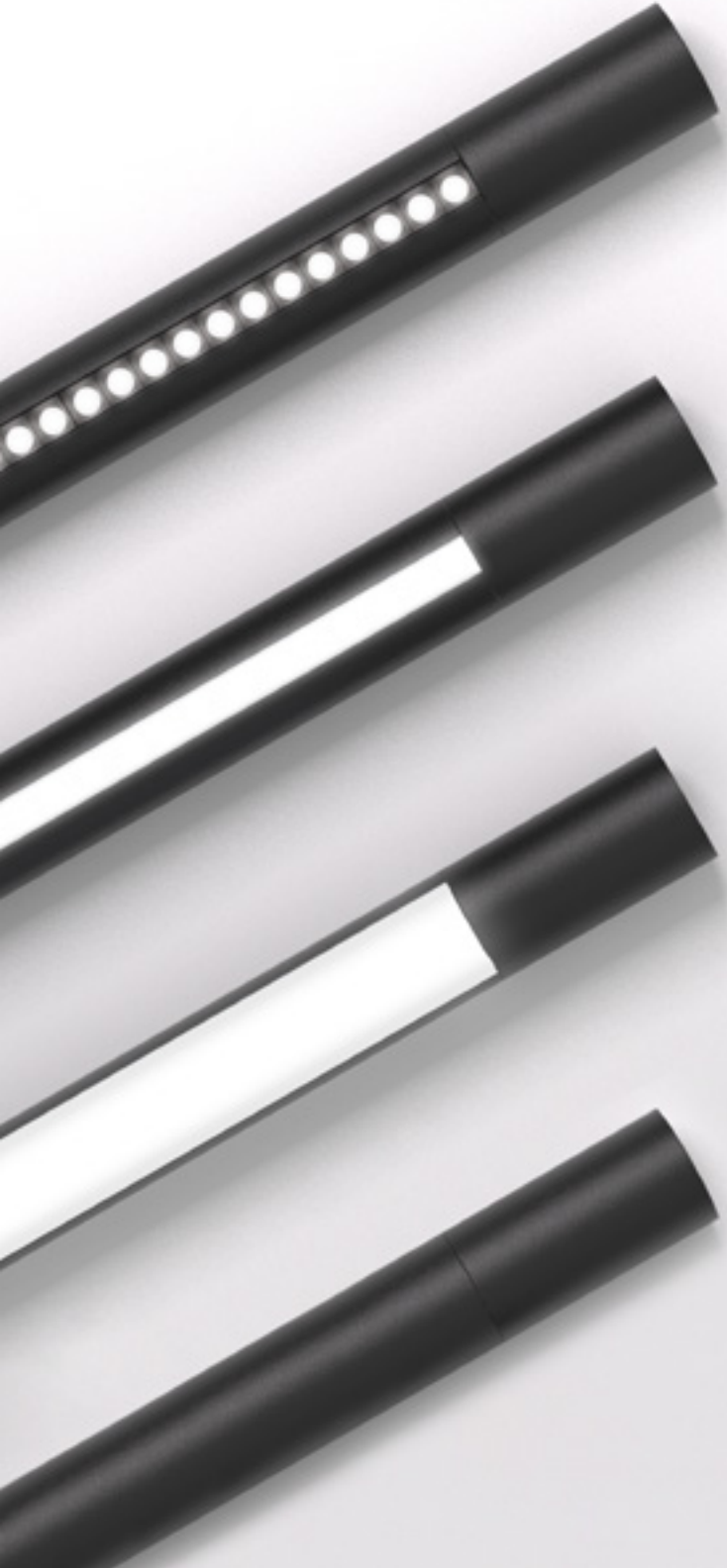

## **BAFFLED OPTIC**

---

Offered with 22° or 55° beam angles (FWHM), the baffled optic offers a precise cut-off angle and recessed cell-lens technology to maintain a discreet and minimal presence.

## **HE TECH™**

---

The proprietary HE Tech™ provides high performance and excellent light distribution from a narrow 1/2" aperture diffuse lens.

## **DIFFUSE LENS**

---

Delivering beautifully refined light with uncompromised performance, the diffuse lens is used for a wider lambertian distribution.

## **NO LIGHT**

---

Unlit segments to bridge the gap between lit sections.



## HAVE IT YOUR WAY

Aloft is a sleek, low profile, cylindrical luminaire system that enables specifiers the utmost control. Use the full swivel joiner to create a unique lighting environment.

a·light

01

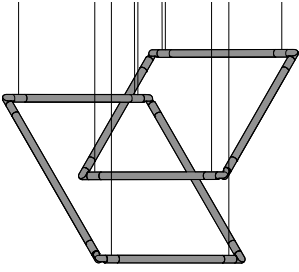

02

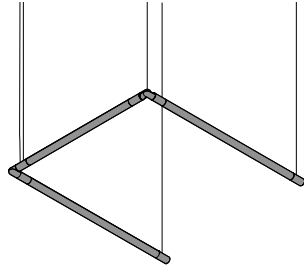

03

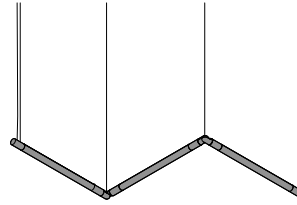

04

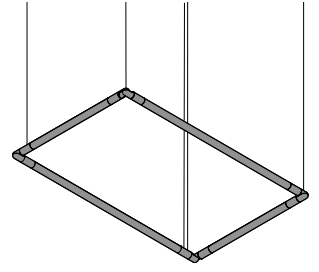

05

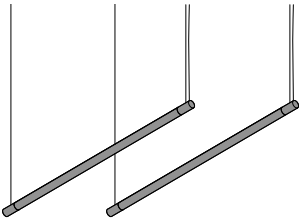

06

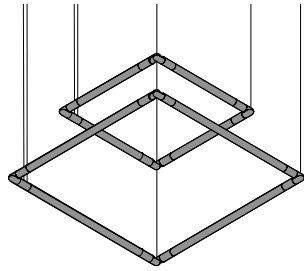

07

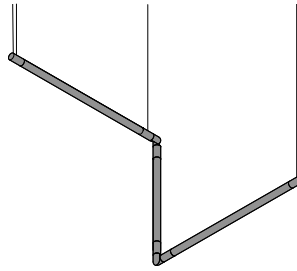

08

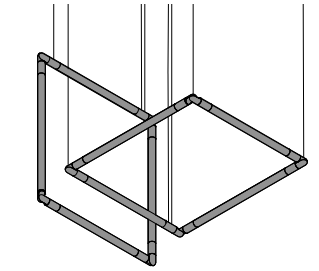

09

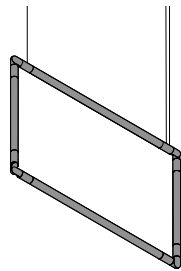

10

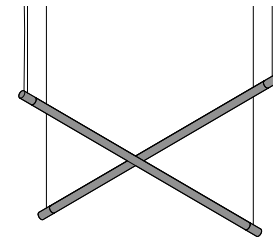

11

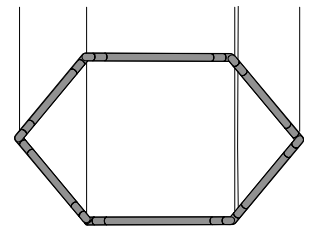

**LIMITLESS OPTIONS**

These are a few of our favorite Aloft shapes and patterns. What will you create?

12

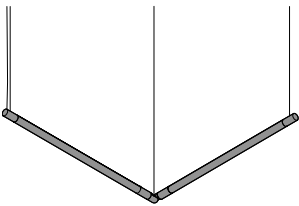

13

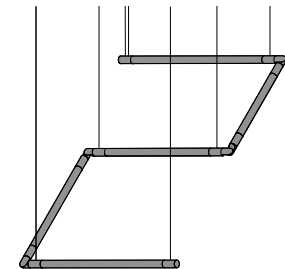

14

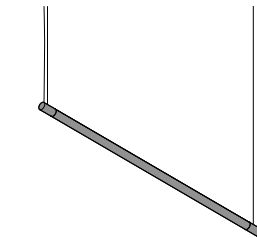

15

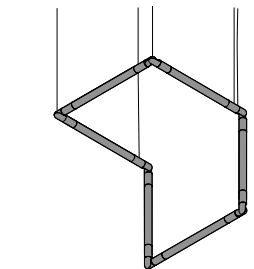

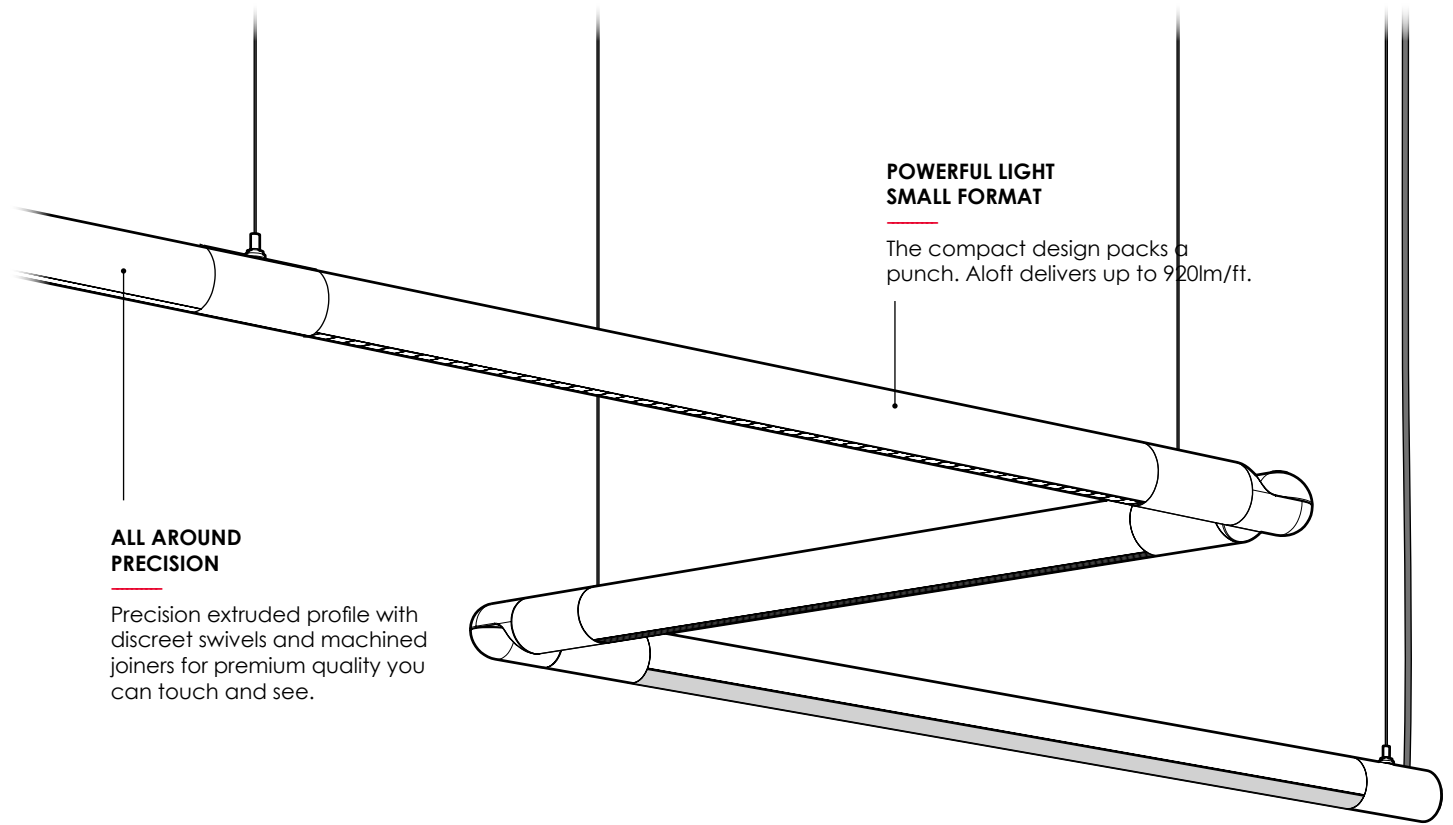

**ALL AROUND  
PRECISION**

Precision extruded profile with discreet swivels and machined joiners for premium quality you can touch and see.

**POWERFUL LIGHT  
SMALL FORMAT**

The compact design packs a punch. Aloft delivers up to 920lm/ft.

**nLIGHT®  
ENABLED**

A-Light's luminaires have the option to use nLight® lighting control solutions.



**ADAPTS TO  
ANY SPACE**

Easily re-configurable end-cap and joiner system makes Aloft ideal for any given space from minimalist architectural hallways to next generation serpentine staircases.

**AIRCRAFT CABLE  
MOUNTING**

A simple and elegant mounting system that provides the effect of a floating form.

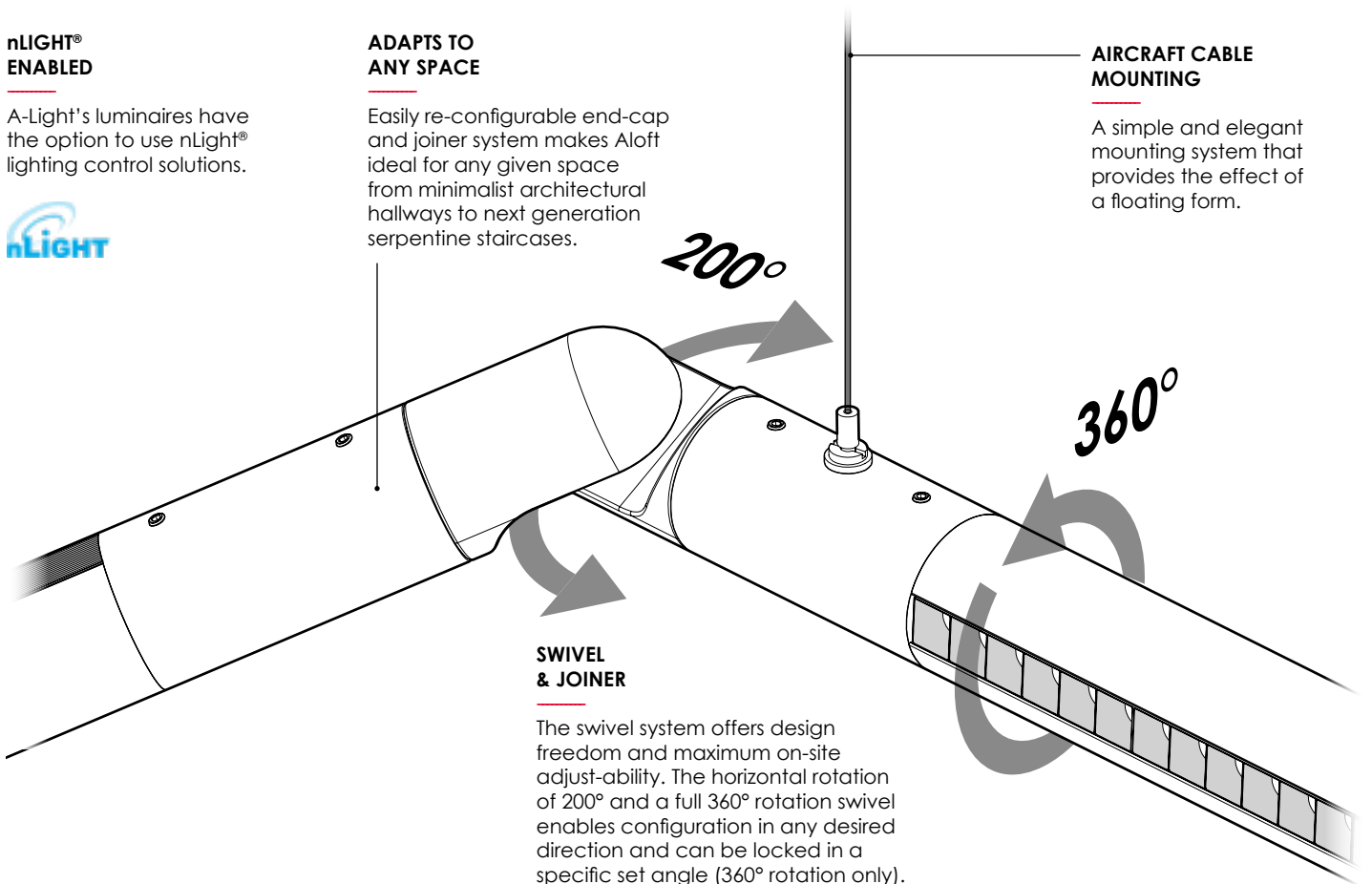

**SWIVEL  
& JOINER**

The swivel system offers design freedom and maximum on-site adjust-ability. The horizontal rotation of 200° and a full 360° rotation swivel enables configuration in any desired direction and can be locked in a specific set angle (360° rotation only).

# a · light

3728 Maritime Way, Oceanside CA, 92056  
760-727-7675 | [alights.com](http://alights.com)



Assembled in America

**Acuity**Brands.